



B4MAGNASM

4' MAGNA STYLE BENCH SURFACE MOUNT DESIGN

WEBCOAT PRODUCTS
P.O. BOX 3160
McALESTER, OKLAHOMA 74501
1-800-505-5101
FAX: (918)426-5924
E-MAIL: WEBCOAT@WEBCOAT.COM

Please take the time to locate and identify each part. Assemble the units on a smooth flat surface. It is also helpful to lay the tops and seats on cardboard or a drop cloth to prevent scratching of the surface during assembly. All parts have been pre-cut and pre-drilled for ease of assembly. All holes are slotted to allow for easy assembly and for final levelling of tops and seats to frames. Fully assemble all parts without totally tightening nuts and bolts. After all assembled go back and retighten nuts to bolts. DO NOT OVER TIGHTEN NUTS TO BOLTS. Over tightened nuts can crack the plastisol coating. All the necessary quantities of parts required are listed in this assembly instructions.

DO NOT BEGIN ASSEMBLY UNTIL YOU HAVE READ THESE INSTRUCTIONS AND ARE FAMILIAR WITH THE PARTS.



PARTS IDENTIFICATION

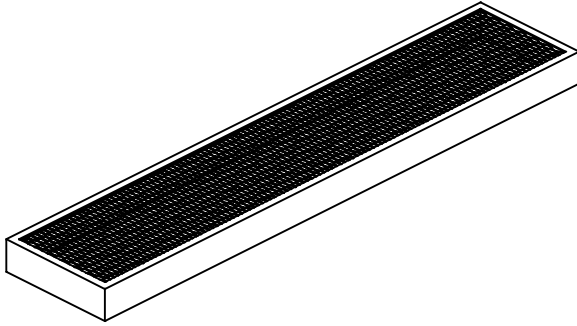

(A) 4' MAGNA SEAT



(B) BENCH FRAME

PARTS LIST

ITEM	PART#	DESCRIPTION	QTY.
A	S4MAGNA	4' MAGNA SEAT	1
B	F30	BENCH FRAME	2

ITEM	HARDWARE DESCRIPTION	QTY.
HW1	5/16" X 18 NYL LOCKNUTS	4
HW2	5/16" X 18GA CAP BOLTS	4
HW3	5/16" FLAT WASHERS	8
HW4	BOLT GUARDS	4

ASSEMBLY TOOLS REQUIRED
2- 1/2" WRENCHES

HARDWARE IDENTIFICATION



(HW1) 5/16" X 18
NYL LOCKNUTS

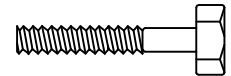

(HW2) 5/16" X 18
GAUGE CAP BOLTS



(HW3) 5/16"
FLAT WASHERS



(HW4) BOLT
GUARDS

ASSEMBLY PROCEDURES

STEP 1

MOUNT THE SEAT BY MEANS OF FOUR 5/16" X 1 1/2" HEXBOLTS, EIGHT 5/16" FLAT WASHERS AND FOUR 5/16" NYLOCK NUTS THROUGH THE SLOTTED HOLES ON THE SEATS AND THROUGH THE SLOTTED HOLES ON THE ANGLE IRON OF THE FRAMES. Hand tighten only at this time.

STEP 2

MOUNT THE FRAMES TO A FLAT LEVEL SURFACE.
SURFACE MOUNTING HARDWARE NOT INCLUDED.

STEP 3

TIGHTEN ALL NUTS ON ALL BOLTS AND PLACE THE BOLT GUARDS ON ALL NUTS. DO NOT OVER TIGHTEN THE NUTS AS THIS COULD CAUSE THE PLASTISOL COATING TO CRACK.

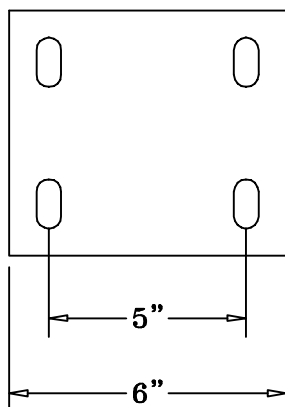
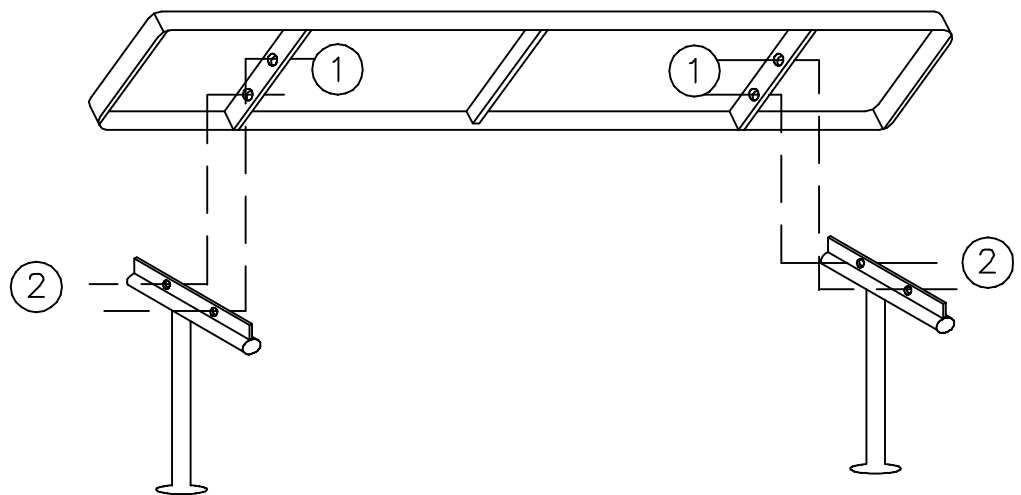

1	CAP. BOLT & WASHER
2	WASHER & LOCK NUT

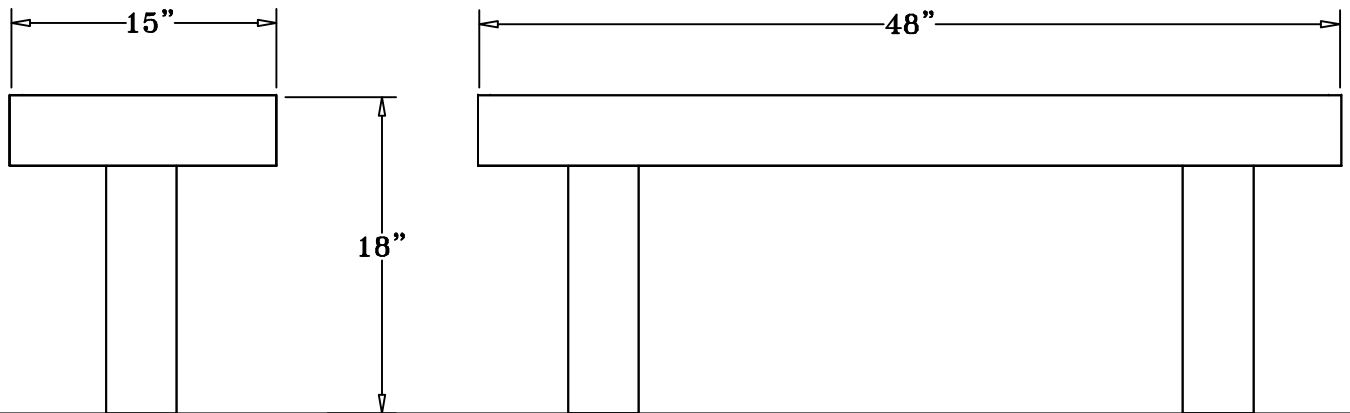

SPECIFICATIONS

4' POLY VINYL COATED ROLLED EXPANDED METAL BENCH WITH OUT BACK.
FRAME IS 4' SQ. SURFACE MOUNT DESIGN.

COATED WITH A 1/8" TO 1/4" THICK PLASTISOL ULTRAVIOLET STABILIZED VINYL COATING FUSED AND BAKED TO A 90% GLOSS.

SEAT HEIGHT IS 18" APPROXIMATELY. TOTAL OVERALL DIMENSIONS ARE 48" X 15".

SEAT IS MADE FROM HEAVY DUTY 3/4" #9 EXPANDED METAL INSIDE A 1" X 4" X 1/8" FORMED ANGLE FRAME.

FRAMES ARE MADE OF 4" SQ. POSTS MOUNTED BY ANGLE IRONS TO EACH END OF THE SEAT.
COATED WITH A BAKED ON POLYESTER POWDER COAT FINISH.

SURFACE MOUNT PLATE IS MADE FROM 1/4" X 6" X 6" FLAT STEEL.

ALL HARDWARE IS NON-CORROSIVE.
WEIGHT FOR THE B4MAGNASM IS 70 LBS.

MAINTENANCE

To maintain luster it is recommended to wash, rinse, and dry the units after prolonged use. Check for loose bolts and nuts and tighten as needed. Contact the factory for genuine Webcoat part replacements if needed.