



B6WBMODERNS

6' MODERN STYLE
BENCH WITH BACK
INGROUND MOUNT DESIGN

WEBCOAT PRODUCTS
P.O. BOX 3160
McALESTER, OKLAHOMA 74501
1-800-505-5101
FAX: (918)426-5924
E-MAIL: WEBCOAT@WEBCOAT.COM

Please take the time to locate and identify each part. Assemble the units on a smooth flat surface. It is also helpful to lay the tops and seats on cardboard or a drop cloth to prevent scratching of the surface during assembly. All parts have been pre-cut and pre-drilled for ease of assembly. All holes are slotted to allow for easy assembly and for final levelling of tops and seats to frames. Fully assemble all parts without totally tightening nuts and bolts. After all assembled go back and retighten nuts to bolts. DO NOT OVER TIGHTEN NUTS TO BOLTS. Over tightened nuts can crack the plastisol coating. All the necessary quantities of parts required are listed in this assembly instructions.

DO NOT BEGIN ASSEMBLY UNTIL YOU HAVE READ THESE INSTRUCTIONS AND ARE FAMILIAR WITH THE PARTS.



PARTS IDENTIFICATION

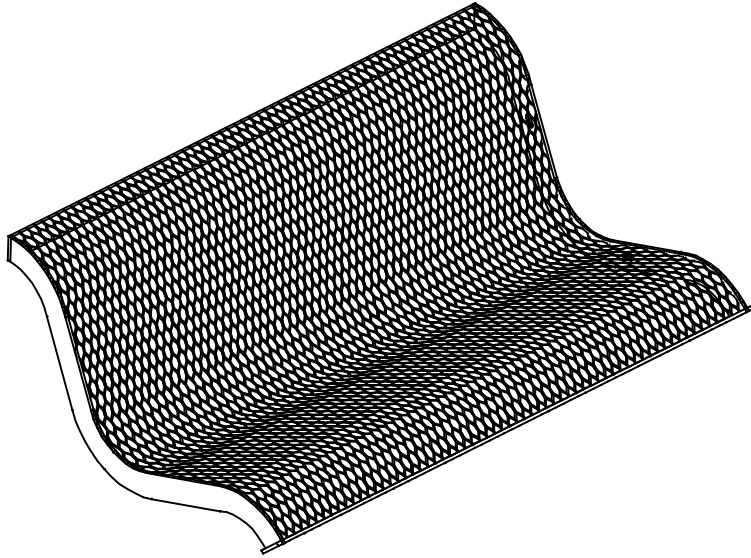

(A) 6' MODERN SEAT WITH BACK

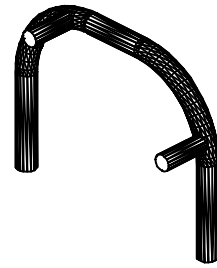

(B) BENCH FRAME

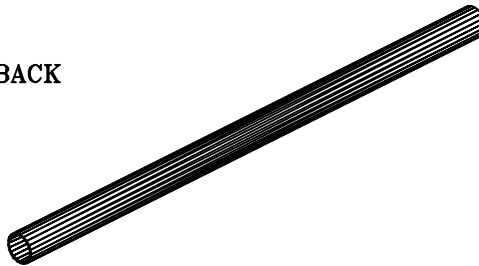

(C) CONNECTING PIPE

PARTS LIST

ITEM	PART#	DESCRIPTION	QTY.
A	S6WBMODERN	6' MODERN SEAT W/BACK	1
B	FBWBMODERNS	MODERN BENCH FRAME	2
C	F6CPIPE	CONNECTING PIPE	2

ITEM	HARDWARE DESCRIPTION	QTY.
HW1	5/16" X 18 NYL LOCKNUTS	4
HW2	5/16" X 18GA CAP BOLTS	4
HW3	5/16" FLAT WASHERS	8
HW4	BOLT GUARDS	4

ASSEMBLY TOOLS REQUIRED
2- 1/2" WRENCHES

HARDWARE IDENTIFICATION



(HW1) 5/16" X 18
NYL LOCKNUTS

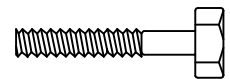

(HW2) 5/16" X 18
GAUGE CAP BOLTS



(HW3) 5/16"
FLAT WASHERS



(HW4) BOLT
GUARDS

ASSEMBLY PROCEDURES

STEP 1

CONNECT THE TWO END FRAMES TOGETHER BY PLACING FLARED ENDS OVER THE 6" STUBS ON THE END FRAMES.

STEP 2

SET BENCH SEAT ON FRAME WITH BENCH END BRACES ON OUTSIDE OF FRAME MOUNTING BRACKETS. FASTEN TOGETHER BY USING FOUR 1 1/2" X 5/16" BOLTS AND NUTS AND EIGHT WASHERS. HAND TIGHTEN ONLY AT THIS TIME.

STEP 3

FOLLOWING FOOTING DIAGRAM BELOW, DIG FOUR HOLES APPROXIMATELY 20" DEEP X 12" DIA. SET BENCH IN HOLES, LEVEL AND MAKE CERTAIN TOP OF SEAT IS 16 1/2" FROM GROUND. FILL HOLES WITH CONCRETE AN LET STAND FOR 24 HOURS BEFORE USE.

STEP 3

TIGHTEN ALL NUTS ON ALL BOLTS SECURELY.

DO NOT OVER TIGHTEN AS THIS WILL CAUSE THE PLASTISOL COATING TO CRACK.

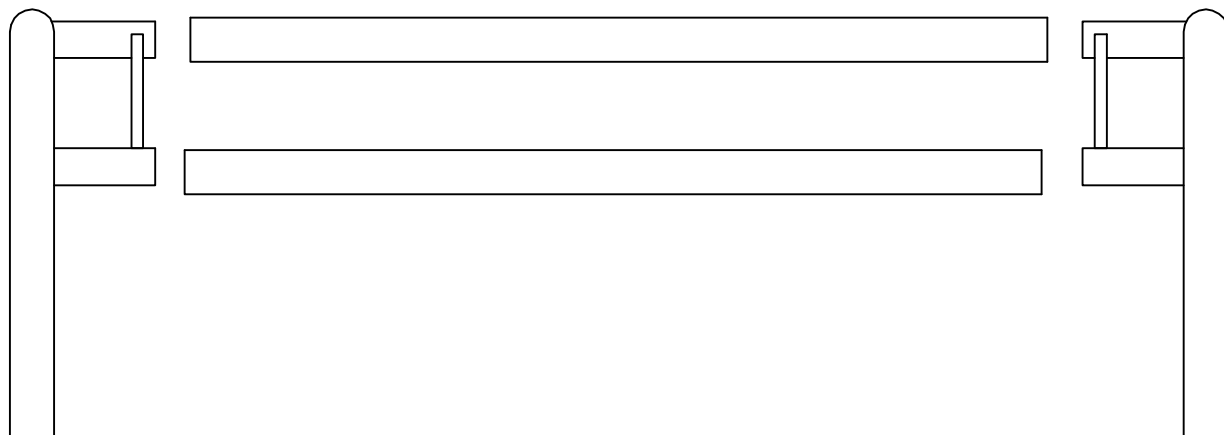
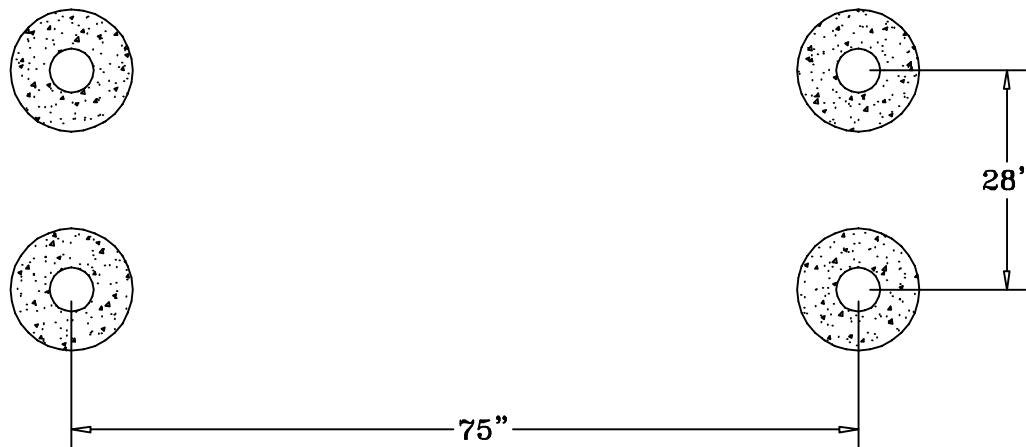

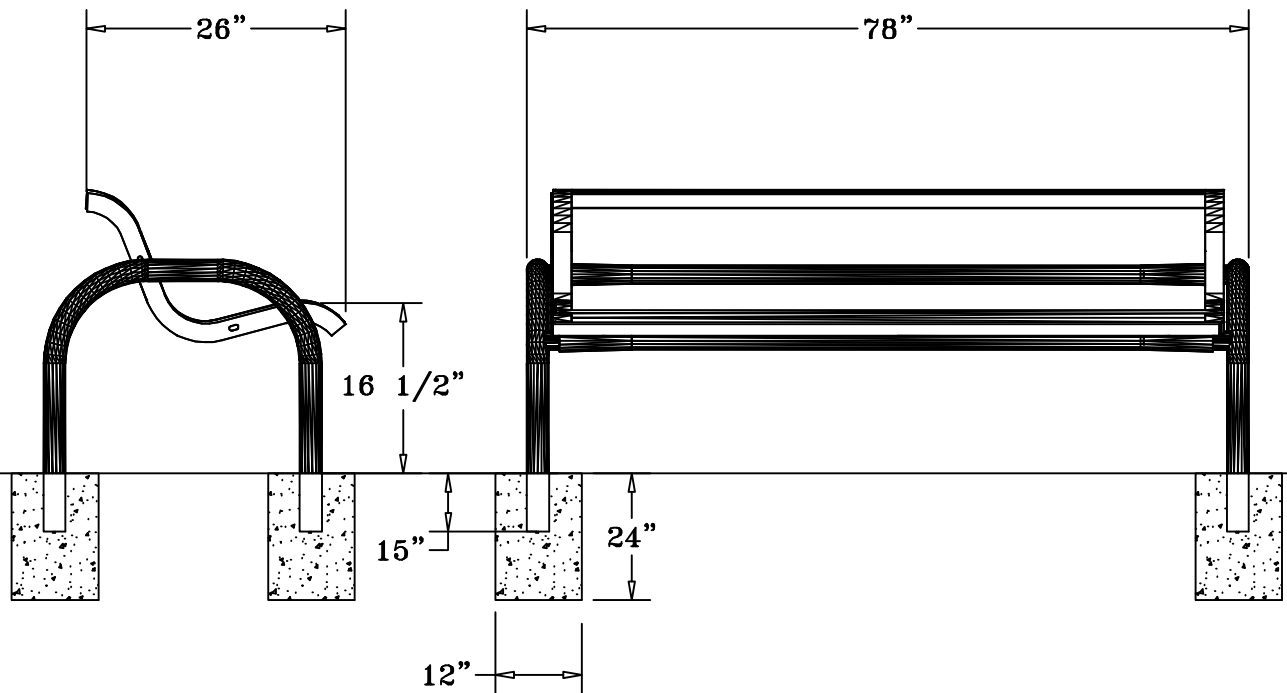

SPECIFICATIONS

6' POLY VINYL CURVED EXPANDED METAL MODERN BENCH WITH BACK. THE ONE PIECE DESIGN CREATES THE CONTEMPORARY LOOK WITH THE MAXIMUM OF STRENGTH. FRAME IS INGROUND MOUNT DESIGN.

COATED WITH A 1/8" TO 1/4" THICK PLASTISOL ULTRAVIOLET STABILIZED VINYL COATING FUSED AND BAKED TO A 90% GLOSS.

SEAT HEIGHT IS 18" APPROXIMATELY. BACK HEIGHT IS 32" APPROXIMATELY. TOTAL OVERALL DIMENSIONS ARE 72" X 32" APPROXIMATELY.

SEAT IS MADE FROM HEAVY DUTY 3/4" #9 EXPANDED METAL INSIDE A 3/16" FLAT STEEL FRAME.

UNDERSTRUCTURE IS MADE FROM HEAVY WALL TUBING IN A FOUR PIECE DESIGN, FABRICATED TO CREATE ARM RESTS ON EACH END. UNDER FRAME IS MADE OF 2 7/8" GALVANIZED TUBING THAT IS COATED WITH A BAKED ON DRY POLYESTER POWDER COAT FINISH.

ALL HARDWARE IS NON-CORROSIVE.

WEIGHT FOR THE B6WBMODERNS IS 140 LBS.

MAINTENANCE

To maintain luster it is recommended to wash, rinse, and dry the units after prolonged use. Check for loose bolts and nuts and tighten as needed. Contact the factory for genuine Webcoat part replacements if needed.