



T46PERFPED-2S

**46" SQ. PERFORATED HANDICAP
2 SEAT PEDESTAL TABLE
INGROUND MOUNT DESIGN**

WEBCOAT PRODUCTS
P.O. BOX 3160
McALESTER, OKLAHOMA 74501
1-800-505-5101
FAX: (918)426-5924
E-MAIL: WEBCOAT@WEBCOAT.COM

Please take the time to locate and identify each part. Assemble the units on a smooth flat surface. It is also helpful to lay the tops and seats on cardboard or a drop cloth to prevent scratching of the surface during assembly. All parts have been pre-cut and pre-drilled for ease of assembly. All holes are slotted to allow for easy assembly and for final levelling of tops and seats to frames. Fully assemble all parts without totally tightening nuts and bolts. After all assembled go back and retighten nuts to bolts. DO NOT OVER TIGHTEN NUTS TO BOLTS. Over tightened nuts can crack the plastisol coating. All the necessary quantities of parts required are listed in this assembly instructions.

DO NOT BEGIN ASSEMBLY UNTIL YOU HAVE READ THESE INSTRUCTIONS AND ARE FAMILIAR WITH THE PARTS.

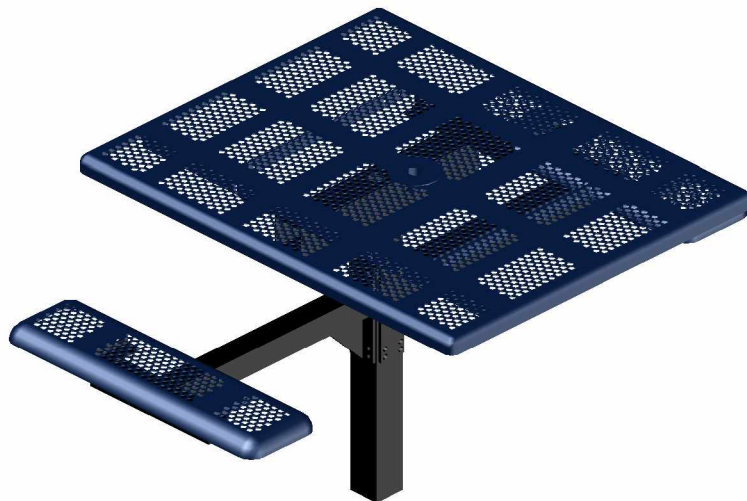

PARTS IDENTIFICATION

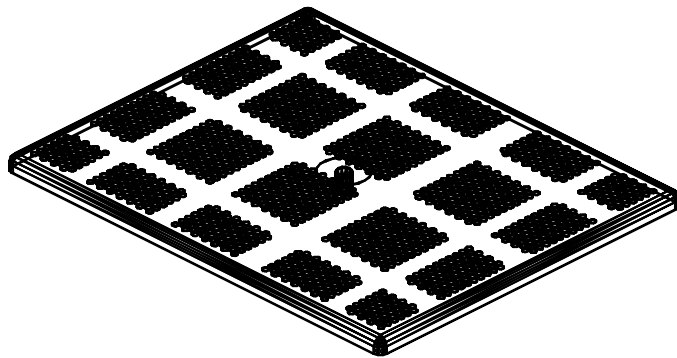

(A) 46" SQ. PERF TOP

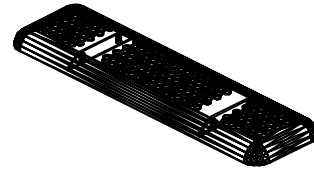

(B) 38" PERF SEAT

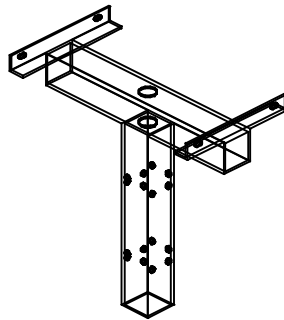

(C) CENTER POST

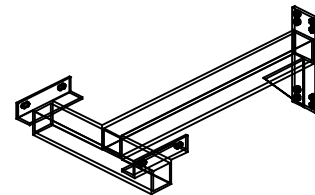

(D) PEDESTAL ARM

PARTS LIST

ITEM	PART#	DESCRIPTION	QTY.
A	TT46PERFHDCP	46"Q. HDCP PERF TOP	1
B	S38PERFHDCP	38" HDCP PERF SEAT	2
C	F46PEDCPS	CENTER POST	1
D	F46PEDARM	PED ARM	2

ITEM	HARDWARE DESCRIPTION	QTY.
HW1	5/16" X 18 NYL LOCKNUTS	12
HW2	5/16" X 18GA CAP BOLTS	12
HW3	5/16" FLAT WASHERS	24
HW4	BOLT GUARDS	12
HW5	5/8" BOLTS	4
HW6	5/8" NUTS	4

ASSEMBLY TOOLS REQUIRED
2- 1/2" WRENCHES

HARDWARE IDENTIFICATION



(HW1) 5/16" X 18
NYL LOCKNUTS

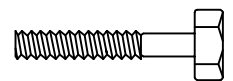

(HW2) 5/16" X 18
GAUGE CAP BOLTS



(HW5) 5/8" NUTS



(HW3) 5/16"
FLAT WASHERS



(HW4) BOLT
GUARDS



(HW6) 5/8" BOLTS

ASSEMBLY PROCEDURES

STEP 1

DIG A FOOTING HOLE 24" SQUARE TO ALLOW FOR 18" OF INGROUND INSTULATION OF PEDESTAL STAND. SET PEDESTAL STAND 18" IN FOOTING HOLE AND PROP IN A PLUMB AND LEVEL POSITION.
POUR CONCRETE AND LET STAND FOR 24 HOURS BEFORE COMPLETING THESE ASSEMBLY INSTRUCTIONS.

STEP 2

BOLT THE ARMS TO THE CENTER PEDESTAL USING 5/8" X 5 1/2" BOLTS & 5/8" NYLOCK NUTS. TIGHTEN BOLTS UP TIGHT.

STEP 3

MOUNT TOP ON CENTER PEDESTAL POST BY MATCHING UP THE HOLES ON BRACES OF THE TOP TO THE HOLES IN THE 2" x 2" ANGLE IRON ON THE POST. MOUNT BY MEANS OF FOUR 5/16" X 1 1/2" CAP BOLTS, EIGHT 5/16" FLAT WASHERS, AND FOUR 5/16" NYLOCK NUTS.

STEP 4

SET EACH OF THE SEATS ON THE SEAT BRACKETS OF THE PEDESTAL ARMS. MATCHING UP THE TWO ARMS UNDER THE SEATS WITH FOUR HOLES ON THE ANGLE IRON BRACE OF THE ARMS. MOUNT BY MEANS OF EIGHT 5/16" X 1 1/2" CAP BOLTS, SIXTEEN 5/16" FLAT WASHERS, AND EIGHT 5/16" NYLOCK NUTS.

STEP 5

TIGHTEN ALL NUTS ON BOLTS AND PLACE BOLT GUARDS ON ALL NUTS. DO NOT OVER TIGHTEN AS THIS COULD CAUSE THE PLASTISOL COATING TO CRACK.

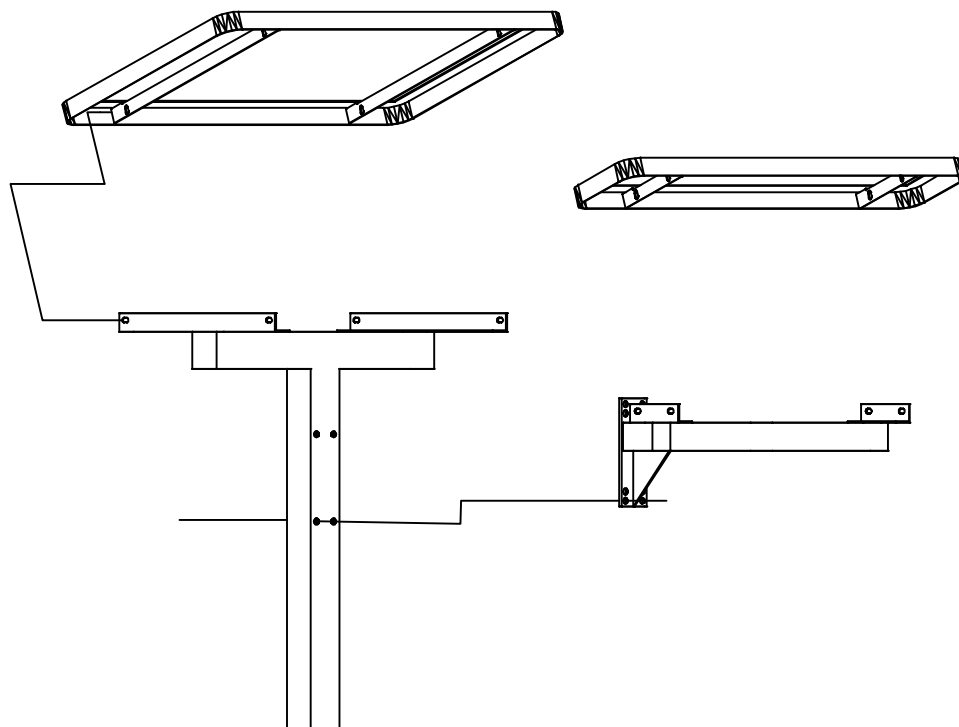

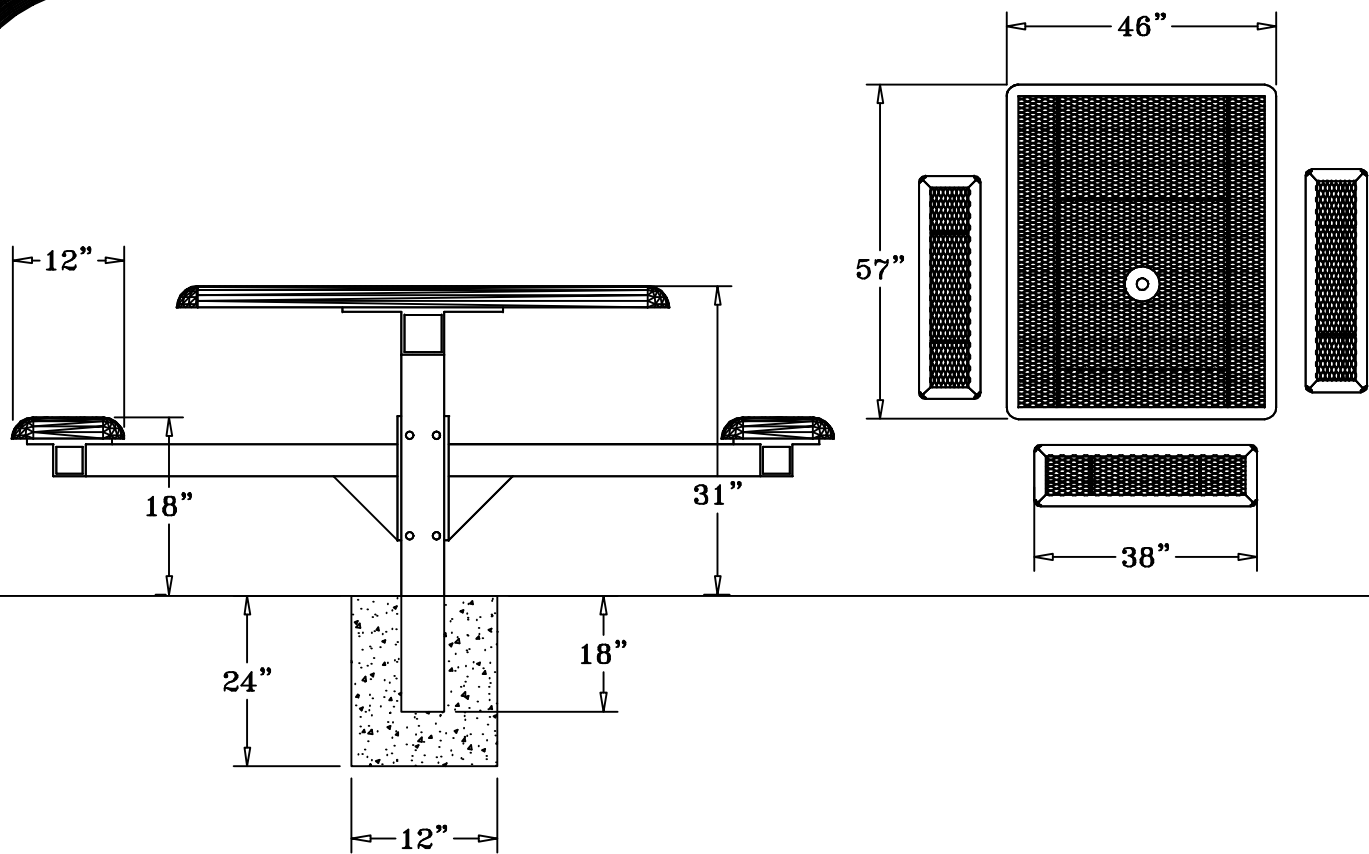

SPECIFICATIONS

46" X 57" PRECISION PUNCHED STEEL TABLE WITH TWO ATTACHED 38" X 12" SEATS. ALL EDGES AND CORNERS ARE ROLLED. FRAME IS INGROUND MOUNT PEDESTAL DESIGN.

COATED WITH A 1/8" TO 1/4" THICK PLASTISOL ULTRAVIOLET STABILIZED VINYL COATING FUSED AND BAKED TO A 90% GLOSS.

TABLE HEIGHT IS 31" APPROXIMATELY. SEAT HEIGHT IS 18" APPROXIMATELY. TOTAL OVERALL SQUARED DIMENSION IS 79".

TOP AND SEATS ARE MADE OF 11GAGE PUNCHED STEEL WITH 3/4" ϕ HOLES. ALL OF THE EDGES OF THE VINYL COATED TOP AND SEATS ARE ROLLED TO A 2" ϕ TO FORM A SMOOTH ROUNDED EDGE. A 1/4" X 1 1/2" STEEL BRACING IS WELDED TO THE UNDERSIDE FOR SUPPORT.

FRAME IS A SINGLE 4" X 4" PEDESTAL MOUNTED TO THE CENTER OF THE TABLE TOP. EXTENDING OUT FROM THE 4" SQUARE TUBING ARE TWO 3" SQUARE TUBING ARMS THAT THE SEATS ARE MOUNTED TO. COATED WITH A BAKED ON POLYESTER POWDER COAT FINISH.

ALL HARDWARE IS NON-CORROSIVE.
WEIGHT FOR THE T46PERFPED-2S IS 373 LBS.

MAINTENANCE

To maintain luster it is recommended to wash, rinse, and dry the units after prolonged use. Check for loose bolts and nuts and tighten as needed. Contact the factory for genuine Webcoat part replacements if needed.