



# T6UL

## 6' UNLIMITED STYLE TABLE PORTABLE DESIGN

WEBCOAT PRODUCTS  
P.O. BOX 3160  
McALESTER, OKLAHOMA 74501  
1-800-505-5101  
FAX: (918)426-5924  
E-MAIL: WEBCOAT@WEBCOAT.COM

Please take the time to locate and identify each part. Assemble the units on a smooth flat surface. It is also helpful to lay the tops and seats on cardboard or a drop cloth to prevent scratching of the surface during assembly. All parts have been pre-cut and pre-drilled for ease of assembly. All holes are slotted to allow for easy assembly and for final levelling of tops and seats to frames. Fully assemble all parts without totally tightening nuts and bolts. After all assembled go back and retighten nuts to bolts. DO NOT OVER TIGHTEN NUTS TO BOLTS. Over tightened nuts can crack the plastisol coating. All the necessary quantities of parts required are listed in this assembly instructions.

DO NOT BEGIN ASSEMBLY UNTIL YOU HAVE READ THESE INSTRUCTIONS AND ARE FAMILIAR WITH THE PARTS.

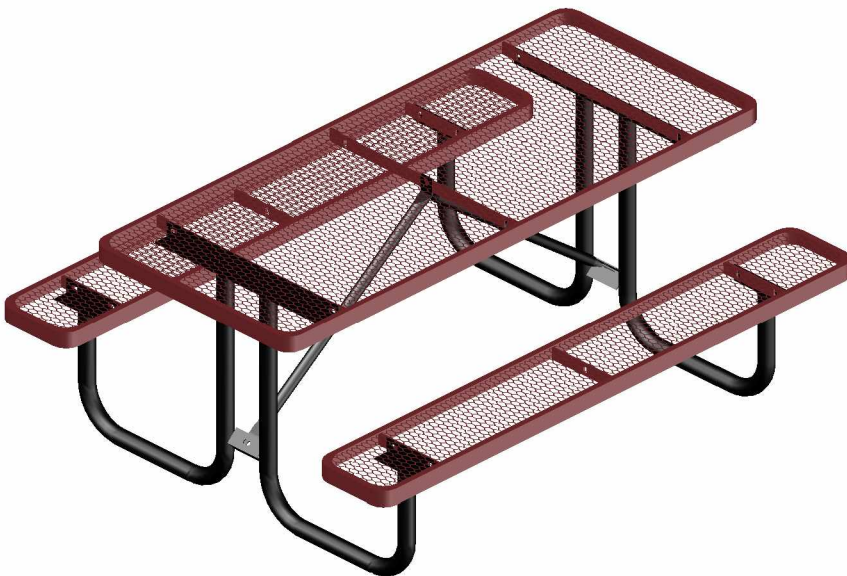

# PARTS IDENTIFICATION

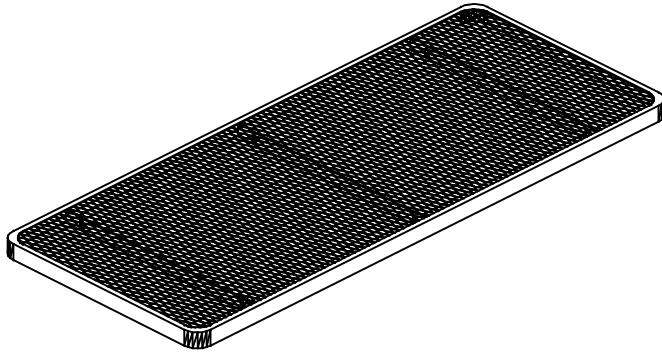

(A) 6' UL TOP

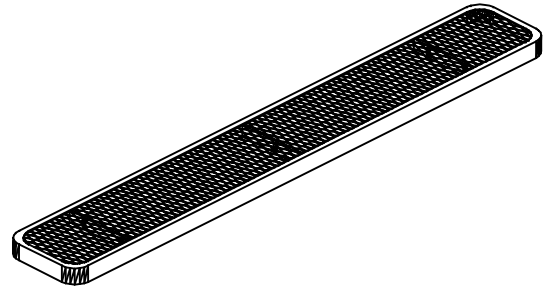

(B) 6' UL SEAT

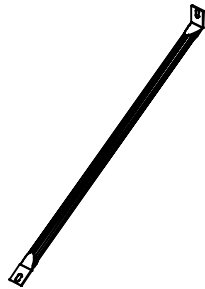

(C) DIAGONAL

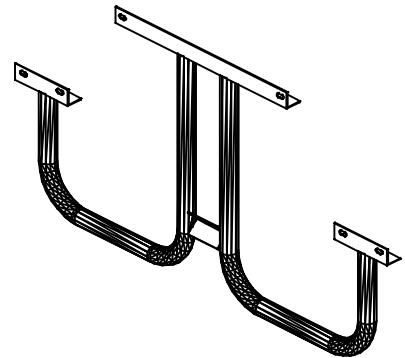

(D) "H" FRAME

## PARTS LIST

ITEM	PART#	DESCRIPTION	QTY.
A	TT6UL	6' UL TOP	1
B	S6UL	6' UL SEAT	2
C	D6T	DIAGONAL	2
D	FH	"H" FRAME	2

ITEM	HARDWARE DESCRIPTION	QTY.
HW1	5/16" X 18 NYL LOCKNUTS	15
HW2	5/16" X 18GA CAP BOLTS	15
HW3	5/16" FLAT WASHERS	30
HW4	BOLT GUARDS	15

ASSEMBLY TOOLS REQUIRED  
2- 1/2" WRENCHES

## HARDWARE IDENTIFICATION



(HW1) 5/16" X 18  
NYL LOCKNUTS

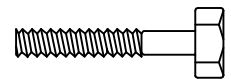

(HW2) 5/16" X 18  
GAUGE CAP BOLTS



(HW3) 5/16"  
FLAT WASHERS



(HW4) BOLT  
GUARDS



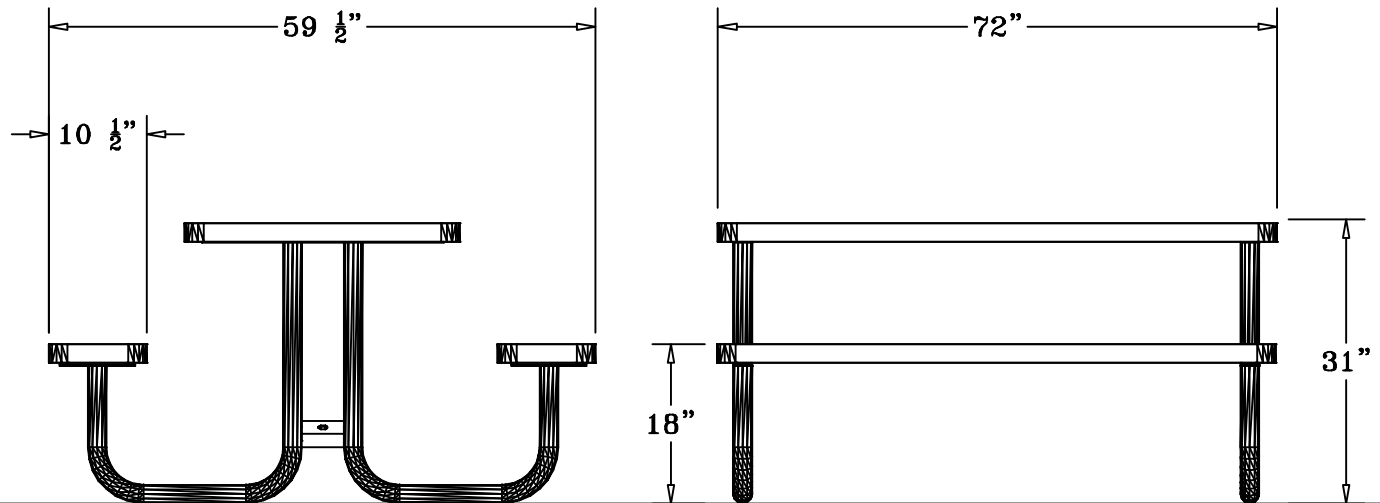

## SPECIFICATIONS

6' POLY VINYL COATED EXPANDED METAL TABLE TOP WITH TWO ATTACHED 72" X 10 1/2" SEATS. ALL CORNERS ARE ROUNDED. THE FRAME IS PORTABLE DESIGN.

COATED WITH A 1/8" TO 1/4" THICK PLASTISOL ULTRAVIOLET STABILIZED VINYL COATING FUSED AND BAKED TO A 90% GLOSS.

TABLE HEIGHT 31" APPROXIMATELY. SEAT HEIGHT IS 18" APPROXIMATELY. TOTAL OVERALL DIMENSIONS ARE 72" X 59 1/2" APPROXIMATELY.

TOP AND SEATS ARE MADE WITH HEAVY DUTY 3/4" #9 EXPANDED METAL INSIDE OF A 2" X 3/4" X 1/8" ANGLE IRON FRAME. ALL CENTER BRACES ARE MADE FROM 1/4" X 1 1/2" FLAT STEEL.

FRAME IS A 2 3/8" HEAVY GALVANIZED STEEL TUBING THAT IS GALVANIZED INSIDE AND OUT AND MEETS OR EXCEEDS THE YIELD AND TENSILE OF SCH 40 PIPE. CONSTRUCTED SO AS TO PROHIBIT RAIN WATER FROM COLLECTING AT GROUND LEVEL. COATED WITH A BAKED ON POLYESTER POWDER COAT FINISH.

THE CROSS BRACE IS MADE OF 1" GALV. STEEL TUBING.

ALL HARDWARE IS NON-CORROSIVE.  
WEIGHT FOR THE T6UL IS 217 LB.

## MAINTENANCE

To maintain luster it is recommended to wash, rinse, and dry the units after prolonged use. Check for loose bolts and nuts and tighten as needed. Contact the factory for genuine Webcoat part replacements if needed.