



T6 WIREUP

6' WIRE STYLE TABLE
WITHOUT SEATS
PORTABLE DESIGN

WEBCOAT PRODUCTS
P.O. BOX 3160
McALESTER, OKLAHOMA 74501
1-800-505-5101
FAX: (918)426-5924
E-MAIL: WEBCOAT@WEBCOAT.COM

Please take the time to locate and identify each part. Assemble the units on a smooth flat surface. It is also helpful to lay the tops and seats on cardboard or a drop cloth to prevent scratching of the surface during assembly. All parts have been pre-cut and pre-drilled for ease of assembly. All holes are slotted to allow for easy assembly and for final levelling of tops and seats to frames. Fully assemble all parts without totally tightening nuts and bolts. After all assembled go back and retighten nuts to bolts. DO NOT OVER TIGHTEN NUTS TO BOLTS. Over tightened nuts can crack the plastisol coating. All the necessary quantities of parts required are listed in this assembly instructions.

DO NOT BEGIN ASSEMBLY UNTIL YOU HAVE READ THESE INSTRUCTIONS AND ARE FAMILIAR WITH THE PARTS.



PARTS IDENTIFICATION

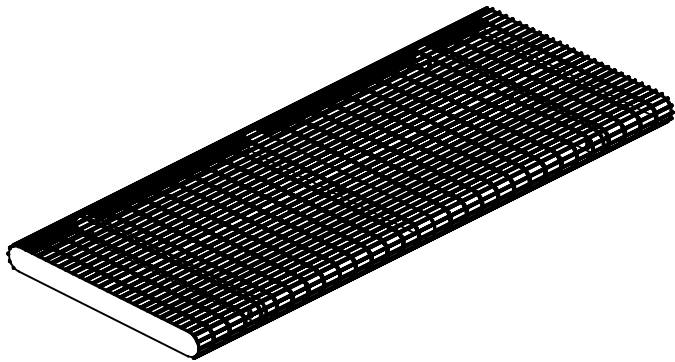

(A) 6' WIRE TOP

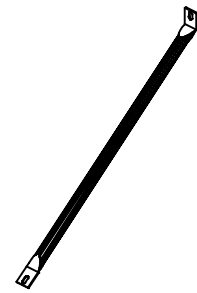

(B) DIAGONAL

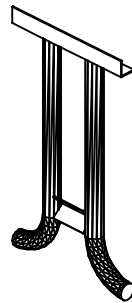

(C) "H" FRAME

PARTS LIST

ITEM	PART#	DESCRIPTION	QTY.
A	TT6WIRE	6' WIRE TOP	1
B	D6T	DIAGONAL	2
C	FHUP	"H" FRAME UP	2

ITEM	HARDWARE DESCRIPTION	QTY.
HW1	5/16" X 18 NYL LOCKNUTS	7
HW2	5/16" X 18GA CAP BOLTS	7
HW3	5/16" FLAT WASHERS	14
HW4	BOLT GUARDS	7

ASSEMBLY TOOLS REQUIRED
2- 1/2" WRENCHES

HARDWARE IDENTIFICATION



(HW1) 5/16" X 18
NYL LOCKNUTS

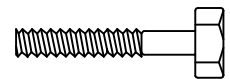

(HW2) 5/16" X 18
GAUGE CAP BOLTS



(HW3) 5/16"
FLAT WASHERS



(HW4) BOLT
GUARDS

ASSEMBLY PROCEDURES

STEP 1

LAY TOP UPSIDE DOWN ON A SMOOTH FLAT SURFACE. MOUNT ONE SET OF H FRAMES TO EACH END OF TABLE, SQUARED TO THE TOP. TABS WELDED ON FRAMES FOR DIAGONALS MUST BE FACING EACH OTHER. ANGLE IRON ON FRAMES MUST BE BOLTED TO OUTSIDE OF BRACES ON TABLE TOP. FASTEN BY MEANS OF FOUR 5/16" X 1 1/2" CAP BOLTS, EIGHT 5/16" FLAT WASHERS AND FOUR 5/16" NYLOCK NUTS. HAND TIGHTEN ONLY AT THIS TIME.

STEP 2

MOUNT THE SET OF DIAGONALS TO HOLE ON CENTER BRACE OF TABLE TOP. MOUNT OTHER END OF DIAGONAL TO THE 1 1/2" X 1 1/2" ANGLE IRON ON FRAME. FASTEN TOGETHER BY MEANS OF THREE 5/16" X 1 1/2" CAP BOLTS, SIX FLAT WASHERS AND FOUR 5/16" NYLOCK NUTS. HAND TIGHTEN ONLY AT THIS TIME.

STEP 3

CAREFULLY SET TABLE UPRIGHT.

STEP 4

TIGHTEN ALL BOLTS IN ALTERNATING PATTERNS TO KEEP THE FRAMES STRAIGHT UNDER THE TOPS AND SEATS AS YOU ARE TIGHTENING.

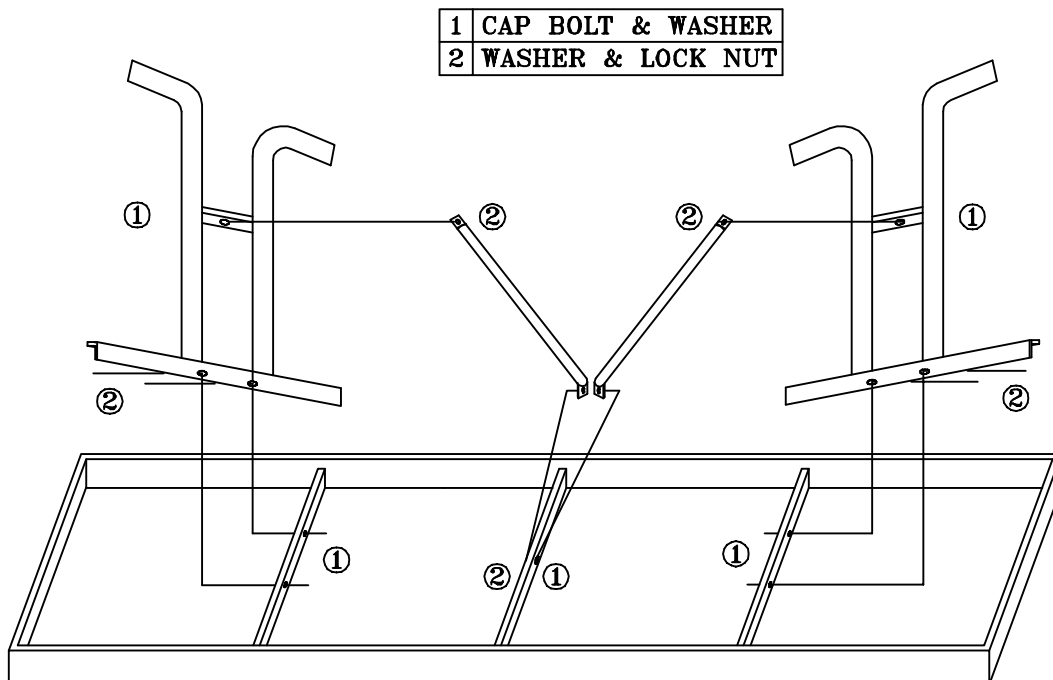

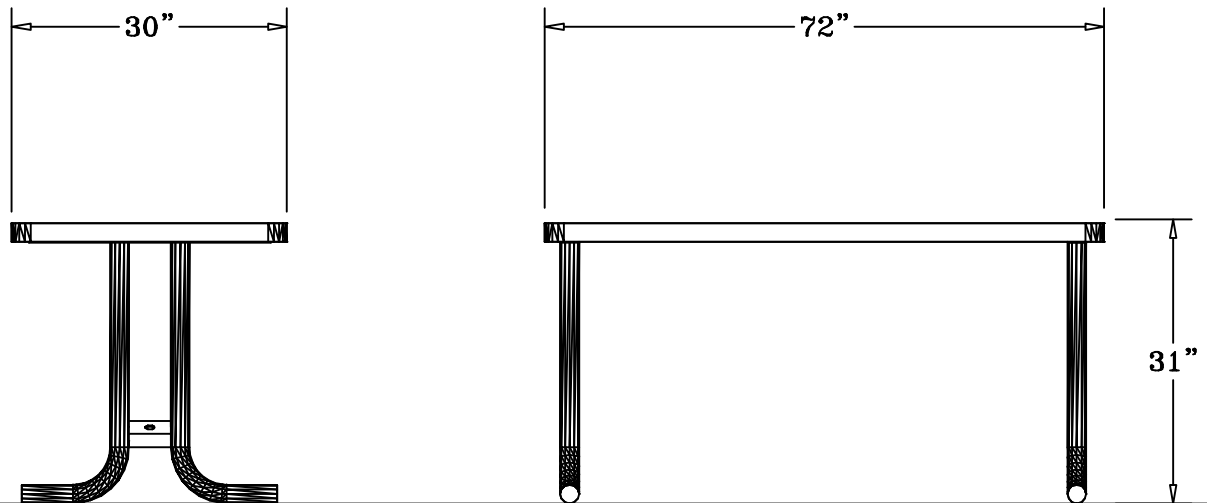

SPECIFICATIONS

6' POLY VINYL WELDED WIRE TABLE TOP WITH NO SEATS.
ALL EDGES ARE ROLLED. THE FRAME PORTABLE DESIGN.

COATED WITH A 1/8" TO 1/4" THICK PLASTISOL ULTRAVIOLET STABILIZED VINYL COATING FUSED AND BAKED TO A 90% GLOSS.

TABLE HEIGHT IS 31" APPROXIMATELY. SEAT HEIGHT IS 18" APPROXIMATELY.
TOTAL OVERALL DIMENSIONS ARE 72" X 30".

TOP IS MADE FROM 1/4" WELDED WIRE BORDERED WITH 1/2" ROUNDS.
ALL CENTER BRACES ARE MADE FROM 1/4" X 1 1/2" FLAT STEEL.

FRAME IS A 2" HEAVY GALVANIZED STEEL TUBING THAT IS GALVANIZED INSIDE AND OUT AND MEETS OR EXCEEDS THE YIELD AND TENSILE OF SCH 40 PIPE. CONSTRUCTED SO AS TO PROHIBIT RAIN WATER FROM COLLECTING AT GROUND LEVEL. COATED WITH A BAKED ON POLYESTER POWDER COAT FINISH.

THE CROSS BRACE IS MADE OF 1" GALV. STEEL TUBING.

ALL HARDWARE IS NON-CORROSIVE.
WEIGHT FOR THE T6WIREUPIS 178 LBS.

MAINTENANCE

To maintain luster it is recommended to wash, rinse, and dry the units after prolonged use. Check for loose bolts and nuts and tighten as needed. Contact the factory for genuine Webcoat part replacements if needed.