



T8RC4-4SM

8' REGAL STYLE TABLE SURFACE MOUNT PEDESTAL DESIGN

WEBCOAT PRODUCTS
P.O. BOX 3160
McALESTER, OKLAHOMA 74501
1-800-505-5101
FAX: (918)426-5924
E-MAIL: WEBCOAT@WEBCOAT.COM

Please take the time to locate and identify each part. Assemble the units on a smooth flat surface. It is also helpful to lay the tops and seats on cardboard or a drop cloth to prevent scratching of the surface during assembly. All parts have been pre-cut and pre-drilled for ease of assembly. All holes are slotted to allow for easy assembly and for final levelling of tops and seats to frames. Fully assemble all parts without totally tightening nuts and bolts. After all assembled go back and retighten nuts to bolts. DO NOT OVER TIGHTEN NUTS TO BOLTS. Over tightened nuts can crack the plastisol coating. All the necessary quantities of parts required are listed in this assembly instructions.

DO NOT BEGIN ASSEMBLY UNTIL YOU HAVE READ THESE INSTRUCTIONS AND ARE FAMILIAR WITH THE PARTS.

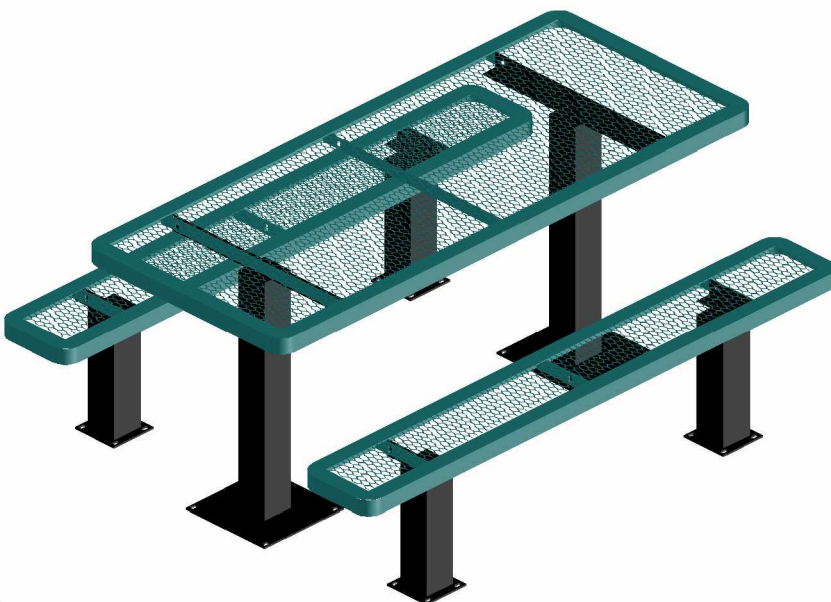

PARTS IDENTIFICATION

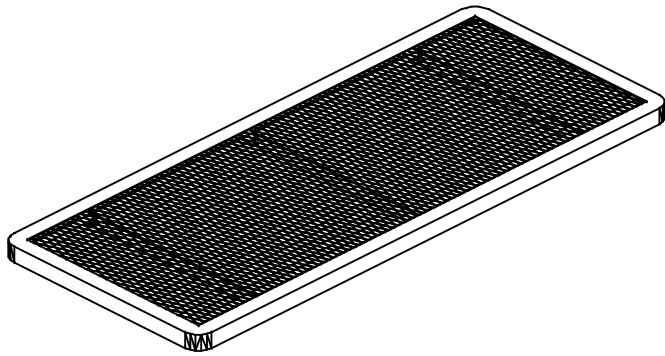

(A) 8' RC TOP

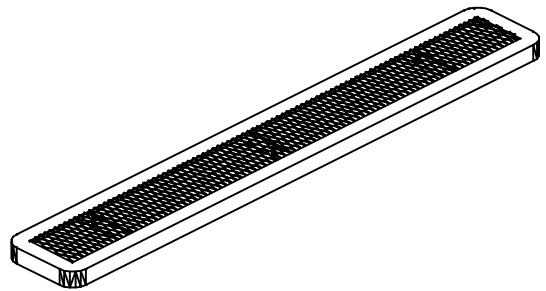

(B) 8' RC SEAT

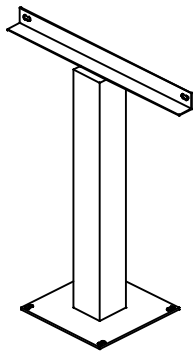

(C) 4" SQ. TABLE POST SM

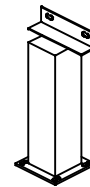

(D) 4" SQ. SEAT POST SM

PARTS LIST

ITEM	PART#	DESCRIPTION	QTY.
A	TT8RC	8' RC TOP	1
B	S8RC	8' RC SEAT	2
C	F48SM	4" SQ. TOP POST	2
D	F30SM	4" SQ. SEAT POST	4

ITEM	HARDWARE DESCRIPTION	QTY.
HW1	5/16" X 18 NYL LOCKNUTS	12
HW2	5/16" X 18GA CAP BOLTS	12
HW3	5/16" FLAT WASHERS	24
HW4	BOLT GUARDS	12

ASSEMBLY TOOLS REQUIRED
2- 1/2" WRENCHES

HARDWARE IDENTIFICATION



(HW1) 5/16" X 18
NYL LOCKNUTS



(HW2) 5/16" X 18
GAUGE CAP BOLTS



(HW3) 5/16"
FLAT WASHERS



(HW4) BOLT
GUARDS

ASSEMBLY PROCEDURES

STEP 1

LAY TOP FACE DOWN ON A SMOOTH FLAT SURFACE. TO PREVENT DAMAGE, DO NOT DRAG PRODUCT.

STEP 2

THE FRAMES MUST BE BOLTED TO THE INSIDE OF BRACES ON THE TOPS AND SEATS. FASTEN BY MEANS OF FOUR 5/16" X 1 1/2" BOLTS, EIGHT FLAT WASHERS AND FOUR 5/16" LOCK NUTS. REPEAT FOR EACH OF THE SEATS.

Hand tighten only at this time.

STEP 3

CAREFULLY TURN TABLE RIGHT SIDE UP.

STEP 4

FOLLOWING THE POST PLACEMENT DIAGRAM BELOW, MOUNT TOP AND SEATS TO A SMOOTH LEVEL SURFACE. SURFACE MOUNTING HARDWARE NOT INCLUDED.

STEP 5

NOW THAT ALL PARTS ARE ASSEMBLED SQUARE AND ALIGN ALL PARTS OF THE UNIT THEN TIGHTEN ALL NUTS ON BOLTS SECURELY. DO NOT OVER TIGHTEN AS THIS WILL CAUSE THE PLASTISOL COATING TO CRACK.



ANGLE BOLTS TO INSIDE OF BRACE, FACING EACH OTHER.

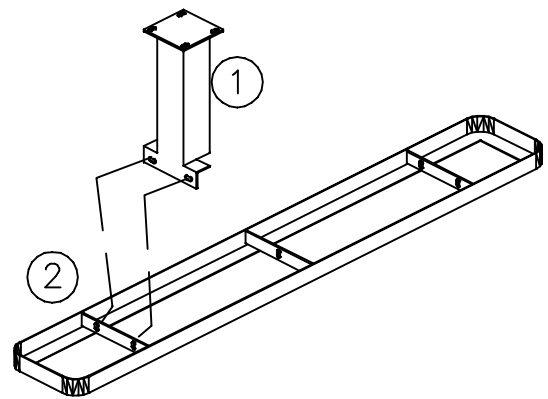
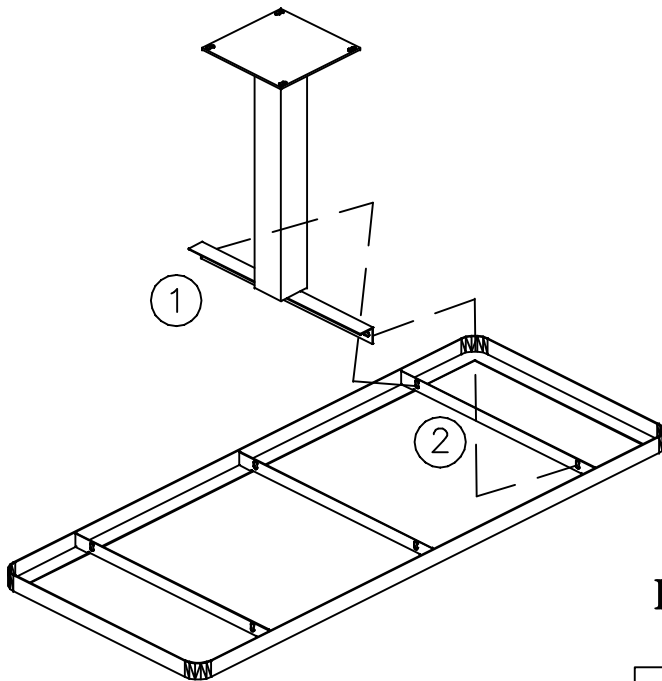

POST PLACEMENT DIAGRAM

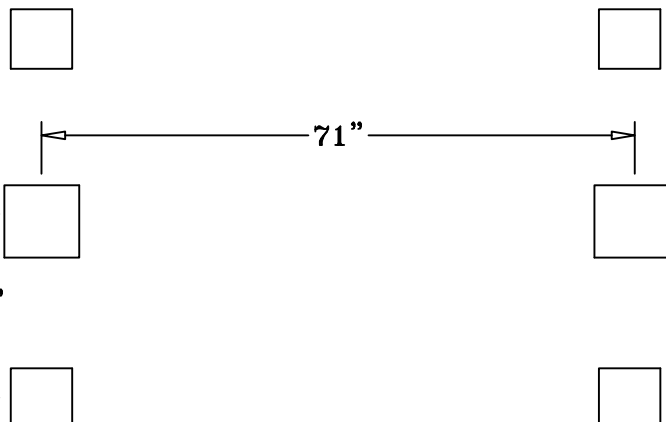

1	CAP. BOLT & WASHER
2	WASHER & LOCK NUT

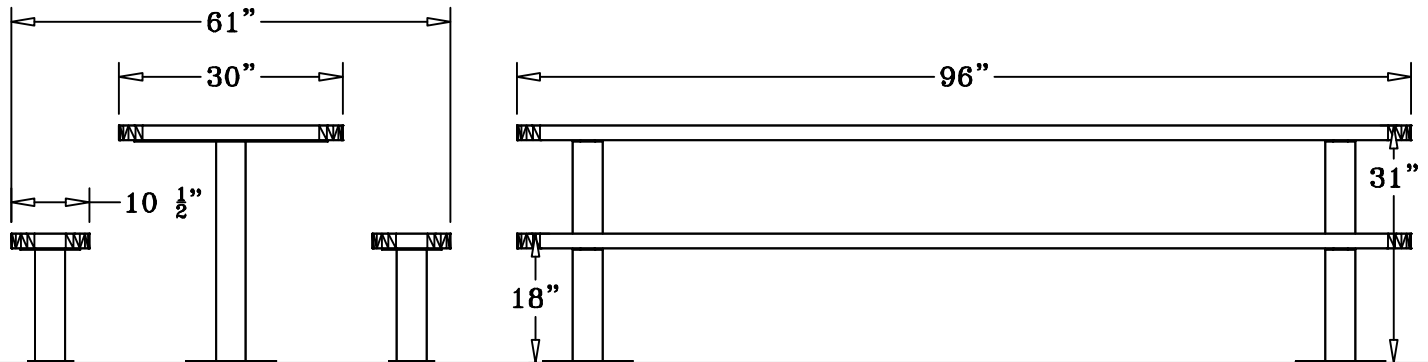

SPECIFICATIONS

8' POLY VINYL EXPANDED METAL TABLE TOP WITH TWO UNATTACHED 96" X 10 1/2" SEATS. ALL CORNERS ARE ROUNDED. THE FRAME IS 4" SQ. SURFACE MOUNT PEDESTAL DESIGN.

COATED WITH A 1/8" TO 1/4" THICK PLASTISOL ULTRAVIOLET STABILIZED VINYL COATING FUSED AND BAKED TO A 90% GLOSS.

TABLE HEIGHT IS 31" APPROXIMATELY. SEAT HEIGHT IS 18" APPROXIMATELY. TOTAL OVERALL DIMENSIONS ARE 96" X 61".

TOP AND SEATS ARE MADE FROM 3/4" #9 EXPANDED METAL INSIDE OF A 2" X 2" X 1/8" ANGLE IRON FRAME. ALL CENTER BRACES ARE MADE FROM 1/4" X 1 1/2" FLAT STEEL.

UNDER FRAMES FOR TOP AND SEATS ARE MADE OUT OF 4" SQ. TUBING POSTS WITH SURFACE MOUNT PLATES ON THE BOTTOMS. THEY ARE THEN POWDER COATED WITH A POLYESTER ELECTROSTATIC PAINT.

SURFACE MOUNT PLATES ARE MADE OF 1/4" FLAT STEEL.

ALL HARDWARE IS NON-CORROSIVE.
WEIGHT FOR THE T8RC4-4SM IS 354 LBS.

MAINTENANCE

To maintain luster it is recommended to wash, rinse, and dry the units after prolonged use. Check for loose bolts and nuts and tighten as needed. Contact the factory for genuine Webcoat part replacements if needed.